



## DEMO BOARD TEST REPORT

# 176-265VAC 150W Two-stage LED Driver with ON/OFF Color Temperature Turning Function Using KP1511SP+KP1073LDP+S4223

## FEATURES

- ON/OFF Color Temperature Turning Function
- Logic State of the Demo is P1→P2→P1+P2
- High PF>0.97 and Low THD<10% with 176~265Vac Input
- Fast Startup < 200ms
- Suitable for 150W High Power Applications
- Minimalist Design to Simplify the BOM
- High Efficiency >91% with 176~265Vac Input
- Excellent Line and Load Regulation
- Built-in Protections:
  - Output Over Voltage Protection (OVP)
  - Cycle-by-Cycle Current Limiting (OCP)
  - On-Chip Thermal Fold back (OTP)

## INTRODUCTION

The Demo Board of KP1511SP+KP1073LDP +S4223 is typically designed for the two-stage LED driver with ON/OFF color temperature turning function. The first stage of the circuit is Boost PFC using KP1511SP, which provides a constant voltage for the input of the second stage. And the second stage of the circuit is Buck using KP1073LDP, which contains two outputs P1 and P2 of 216V/330mA with 176~265Vac. The ON/OFF of P1 and P2 is controlled by the two control signals generated by S4223. According to the action of input ON/OFF, the order of state switching is P1→P2→P1+P2. At the same time, each state has a holding time. When the action interval of two input ON/OFF exceeds the holding time, the state will be reset to the initial state. Besides the multi-protection function, this demo also has very good efficiency, current regulation, high PF, low THD and meet the EN55015 conducted and radiated EMI requirement.

## APPLICATIONS

- High Power Lighting

## DEMO BOARD SEPCIFICATION

Description	Symbol	Min	Type	Max	Unit	Note
Input Voltage	Vin	176		265	Vac	50Hz
Output Voltage	Vout		216		Vdc	
Output Current	Iout		660		mA	
Output Power	Pout		142.6		W	
Efficiency	$\eta$		93.2		%	Typical value tested at 220Vac/50Hz
Power Factor	PF	0.977				Tested at 265Vac/50Hz
Input Current Distortion	THD		8.9		%	Tested at 230Vac/50Hz , IEC6100-3-2 Class C Passed
Startup Time	Tst			150	ms	Tested at 176Vac/50Hz
Surge Test		2000			V	Typical Differential Surge value tested at 220V/50Hz

The table above shows the minimum acceptable performance of the design. Actual performance is listed in the results section.

Demo Board of KP1511SP+KP1073LDP+S4223\_D01\_REV1.0



Board Size (in mm): L x W x H=225.8X35.2X24

Schematic

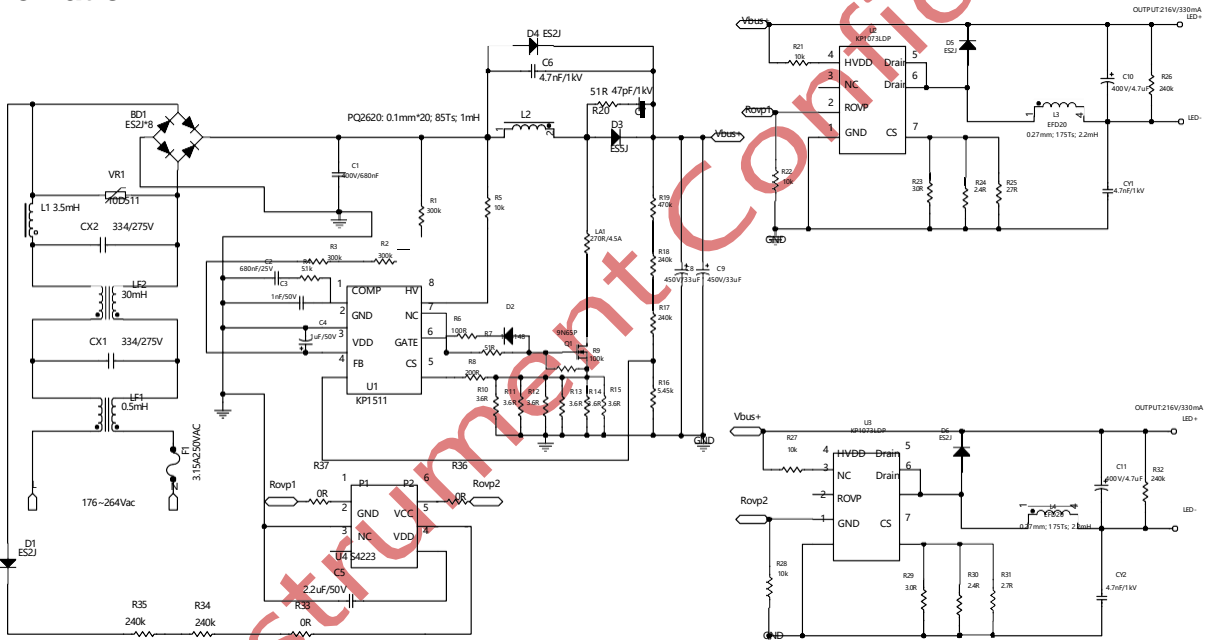

Printed Circuit Board Layout

Top Layer

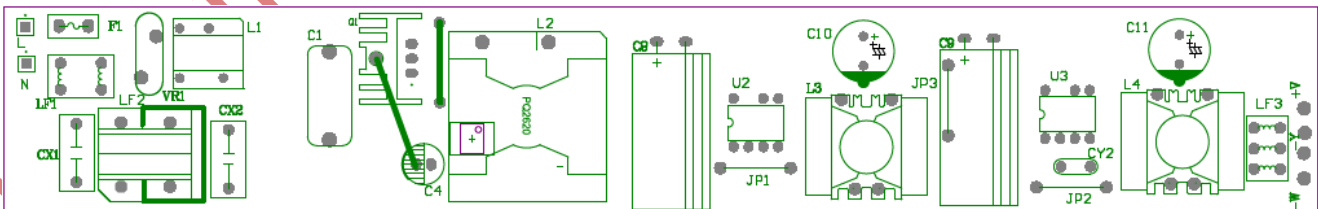

Bottom Layer

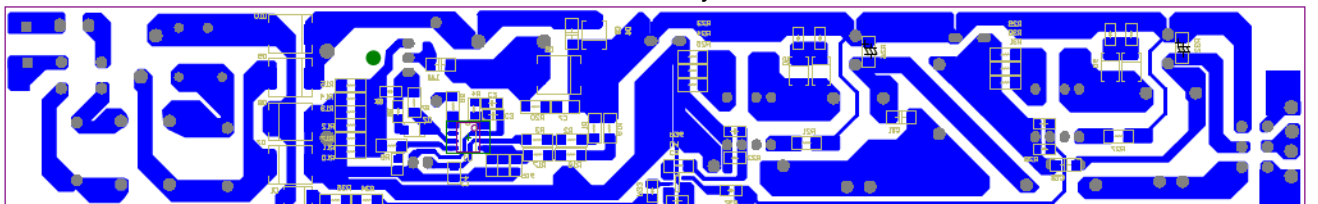



## Circuit Description

The demo board of KP1511SP+KP1073LDP+S4223\_D01 is designed for two-stage LED driver with ON/OFF color temperature turning function application, which simplifies the circuit and saves BOM cost. The demo board can achieve good performance for high efficiency, high PF, low THD, good current regulation and EMI.

### 1. Input Rectification and EMI filtering

The circuit input stage is composed by the components of F1, BD1, CX1, CX2, L1, C1. F1 provides the inrush current limitation in the event of component failure or a short circuit. LF1, LF2, LF3, CX1, CX2, L1, C1 together provide the differential and common mode EMI filtering. The value of F1, C1, VR1 also determine the Surge Test performance. The diode of BD1 rectifies the AC input to DC output.

### 2. KP1511 Operation

KP1511 is a highly integrated Constant Voltage LED Controller with active PFC control for high PF, low THD and high efficiency. The IC adopts accurate voltage sensing and closed loop constant voltage control to achieve high precision CV control.

In KP1511, the inductor demagnetization is detected by monitoring the falling edge of the negative voltage on the gate of power MOSFET. So, no auxiliary winding is needed. KP1511 samples the output voltage through the FB pin and compares it with the internal high-precision reference to maintain a constant output voltage. R16, R17, R18 and R19 are used to program the output voltage. And it is also used for OVP and SCP. When the FB voltage is higher than FB High Voltage Threshold voltage or lower than FB Low Voltage Threshold voltage, the power MOSFET stops switching immediately. KP1511 limits the maximum inductor current through the MOSFET each time the power MOSFET is turned on. When the CS voltage exceeds the peak current reference, the power MOSFET is immediately turned off. R10~R15 is used as sensing resistor. When KP1511 detects a light load, the system will enter Burst mode to improve efficiency of light load and reduce system standby loss.

### 3. KP1073L Operation

In KP1073L, the IC samples the peak inductor current in each switching cycle, which is used as the CC loop feedback, and the high accurate output current can be realized with a high accurate reference. R23~R25 are used as the sensing resistor. KP1073L is integrated with output short protect and output over voltage protect. OVP is detecting by monitoring the voltage of Rovp pin. Additionally, Rovp pin can be used for enable function. MOSFET will stop switching immediately when Rovp pin is connected to GND.

### 4. S4223 Operation

S4223 is Special for switch adjustment of light and color scheme which can output two control signals according to the action of input switch. The IC controls the starting and closing of two constant current power supply according to the high or low of control signals. C5 is used for IC power supply and determining state hold time.



**176-265VAC 150W Two-stage LED Driver with ON/OFF Color Temperature Turning Function Using KP1511SP+KP1073LDP+S4223**

**Bill of Material**

No.	Designator	Value	Description	Package	Manufacturer	Part Number
1	C1	680nF/400V	CBB Cap	TH	Fala	
2	C2	680nF/25V	Ceramic Cap, 25V X7R	0603	Murata	
3	C3	1nF/50V	Ceramic Cap, 50V X7R	0603	Murata	
4	C4	1uF/50V	Ceramic Cap, 50V X7R	0805	Würth Elektronik	
5	C5	2.2uF/50V	Ceramic Cap, 50V X7R	0805	TDK	
6	C6	4.7nF/1000V	Ceramic Cap, 1000V X7R	1206	Murata	
7	C7	47pF/1000V	Ceramic Cap, 1000V X7R	1206	WE	
8	C8, C9	33uF/450V	Electrolytic Cap, 450V, 18*21	TH	WE	
9	C10, C11	4.7uF/450V	Electrolytic Cap, 450V, 10*17	TH	Sancon	
10	CX1, CX2	334/275V	MPX, 275Vac, P=10mm, T=8mm	TH	WE	
11	CY1, CY2	4.7nF/1000V	Ceramic Cap, 1000V X7R	1206	Murata	
12	D1, D4, D5, D6	600V/2A	2 AMP Surface Mount Super Fast Recovery Diode	SMA	Lision	ES2J
13	D2	100V/0.15A	Fast Switching Diode, 100V/0.15A	SOD123	Any	1N4148
14	D3	600V/5A	5 AMP Surface Mount Super Fast Recovery Diode	SMC	Lision	ES5J
15	L1	3.5mH	Inductor, 3.5mH, 10*14	TH	Any	
16	L2	1mH	Single Winding Inductor, Bobbin= PQ2620, Turn=85T, 0.1*20mm	PQ2620	Any	
17	L3, L4	2.2mH	Single Winding Inductor, Bobbin= EFD20, Turn=175T, 0.27mm	EFD20	Any	
18	LF1	0.5mH	Common Mode Power Line Choke	TH	WE	
19	LF2	30mH	Common Mode Power Line Choke	TH	WE	
20	LF3	0.75mH	Common Mode Power Line Choke	TH	Any	
21	F1	3.15A/250V	Fuse 250V/3.15A	TH	Any	
22	BD1	ES2J*8	2 AMP Surface Mount Super Fast Recovery Diode	SMA	Lision	
23	R1, R2, R3	300K	Film Resistor, 5%	1206	Yageo	
24	R4	5.1K	Film Resistor, 5%	0805	Yageo	
25	R5	10K	Film Resistor, 5%	1206	Yageo	
26	R6	100R	Film Resistor, 5% Inductor	0805	Yageo	
27	R7, R20	51R	Film Resistor, 5%	1206	Yageo	
28	R8	200R	Film Resistor, 5%	1206	Yageo	
29	R9	100K	Film Resistor, 5%	0805	Yageo	
30	R10, R11, R12, R13, R14, R15	3.6R	Film Resistor, 5%	1206	Yageo	
31	R16	5.4K	Film Resistor, 5%	0805	Yageo	
32	R17, R18	240K	Film Resistor, 5%	1206	Yageo	
33	R19	470K	Film Resistor, 5%	1206	Yageo	
34	R21, R27	10K	Film Resistor, 5%	1206	Yageo	
35	R22, R28	10K	Film Resistor, 5%	0805	Yageo	
36	R23, R29	3R	Film Resistor, 5%	1206	Yageo	
37	R24, R30	2.4R	Film Resistor, 5%	1206	Yageo	
38	R25, R31	2.7R	Film Resistor, 5%	1206	Yageo	
39	R26, R32	240K	Film Resistor, 5%	1206	Yageo	
40	R33, R36, R37	0R	Film Resistor, 5%	1206	Yageo	
41	R34, R35	240K	Film Resistor, 5%	1206	Yageo	
42	LA1	270R/4.5A	Magnetic beads, 270R±25%, 4.5A@100Mhz	1206	Yageo	BLM31KN271SN1
43	U1	KP1511SP	CV Boost LED Controller	SOP-8	Kiwi Instrument	KP1511SP
44	U2, U3	KP1073LDP	Buck LED Driver	DIP-7	Kiwi Instrument	KP1073LDP
45	U4	S4223	Color Temperature Control Chip	SOT23-6	Infineon Technologies	S4223
46	Q1	AM9N65P	N Mosfet, 650V/9A, R <sub>ds(on)</sub> =1.7ohm@10V	TH	Analog Power	AM9N65P
47	Heatsink	-	Al, L x W x H=14.4X9.3X20.2(mm)	-	Any	
48	Wire	-	Five	-	Any	
49	PCB	-	PCB_KP1511+KP1073LDP+S4223_D01_REV1.0, Board Size (in mm): L x W x H=225.8X35.2X1.25	-	Any	

## Inductor Manufacture Guide (L1)

### 1. Electrical Diagram

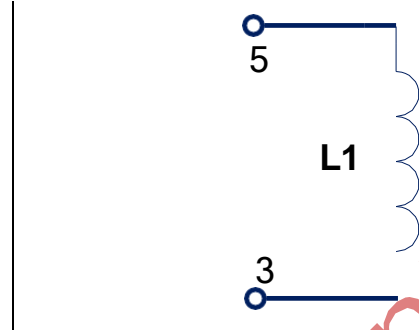
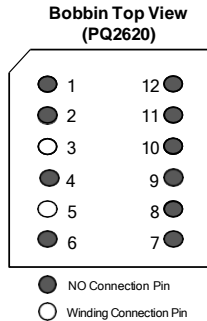

### 2. Winding Diagram

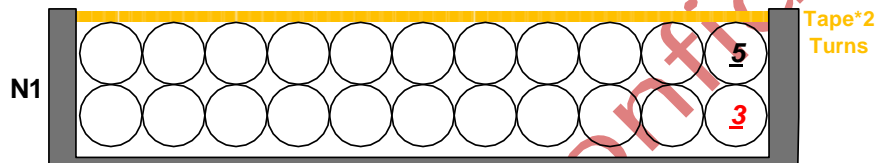

### 3. Winding Order

Number	Winding	Layer	Start	End	Wire Size	Turns	Note
1	N1	Primary	3	5	0.1d*20P	85Ts	
2	Tape					2T	

### 4. Electrical Specification

Items	Test Condition	Test Pin	Standard
Primary Inductance	measured at 40kHz, 1.0 VRMS	Pins 3-5; other windings open	1mH±5%
DC Resistance	-	Pins 3-5	0.4ohm MAX

### 5. BOM

Items	Spec
Core	PQ2620, PC40 or equivalent
Bobbin	PQ2620, 6+6 vertical transformer bobbin
Wire	Φ 0.1 mm *20, 130°C
Tape	3M 1350# Polyester Film

## Inductor Manufacture Guide (L2, L3)

### 1. Electrical Diagram

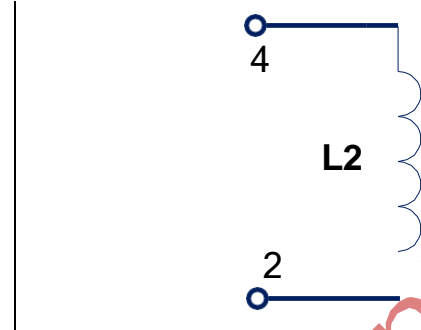
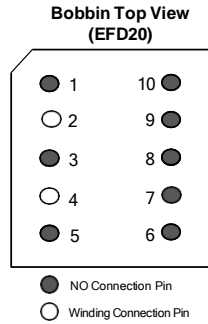

### 2. Winding Diagram

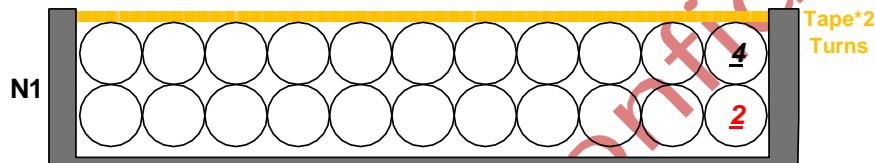

### 3. Winding Order

Number	Winding	Layer	Start	End	Wire Size	Turns	Note
1	N1	Primary	2	4	0.27mm	175Ts	
2	Tape					2T	

### 4. Electrical Specification

Items	Test Condition	Test Pin	Standard
Primary Inductance	measured at 40kHz, 1.0 VRMS	Pins 2-4; other windings open	2.2mH±5%
DC Resistance	-	Pins 2-4	1.5ohm MAX

### 5. BOM

Items	Spec
Core	EFD20, PC40 or equivalent
Bobbin	EFD20, 5+5 vertical transformer bobbin
Wire	Φ 0.27 mm, 130°C
Tape	3M 1350# Polyester Film



**176-265VAC 150W Two-stage LED Driver with ON/OFF Color Temperature Turning Function Using KP1511SP+KP1073LDP+S4223**

**Test Result**

**1. Test Data**

**1) Line Regulation, Efficiency, PF and THD**

VIN (VAC)	Fline (Hz)	Pin (W)	PF	THD	Io (mA)	Vo (V)	Eff (%)
176	50	155.8	0.992	7.8	662.8	216.0	91.89
180		155.4	0.992	8	662.7	216.0	92.11
190		155.0	0.991	8.1	662.6	216.0	92.34
200		154.5	0.99	8.3	662.6	216.0	92.64
210		153.8	0.988	8.6	662.5	216.0	93.04
220		153.5	0.987	8.7	662.4	216.0	93.21
230		153.1	0.985	8.9	662.4	216.0	93.45
240		152.7	0.983	9.1	662.3	216.0	93.68
250		152.4	0.981	9.4	662.3	216.0	93.87
265		151.9	0.977	9.8	662.1	216.0	94.15

**2) High Order Harmonic**

Vin	THD	3	5	7	9	11	13	15
230Vin/50Hz	8.9	7.3	3.2	2.6	1.3	1.1	0.5	0.5

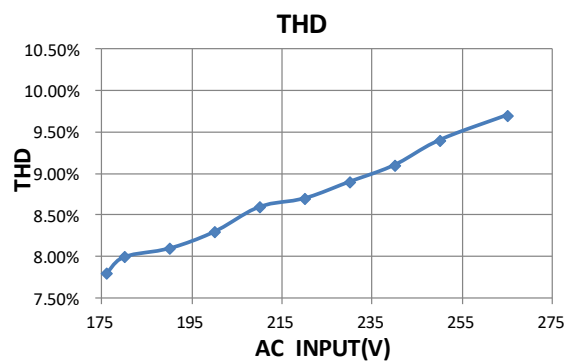
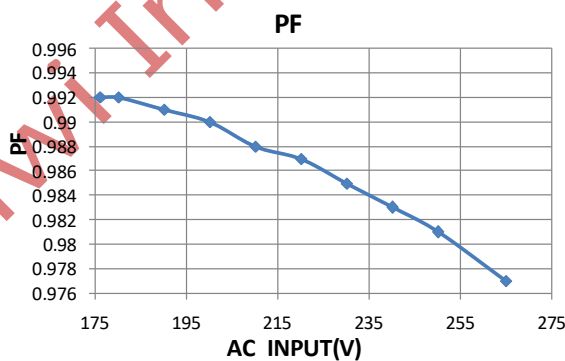
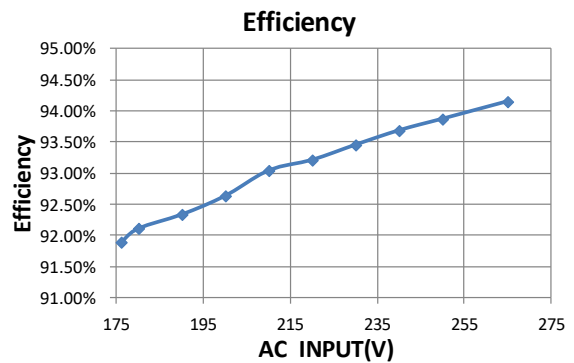
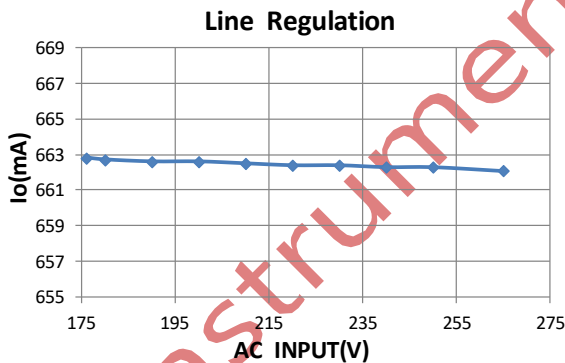



# 176-265VAC 150W Two-stage LED Driver with ON/OFF Color Temperature Turning Function Using KP1511SP+KP1073LDP+S4223

## 2. Operation Curves

### 1) Startup and Shutdown Test

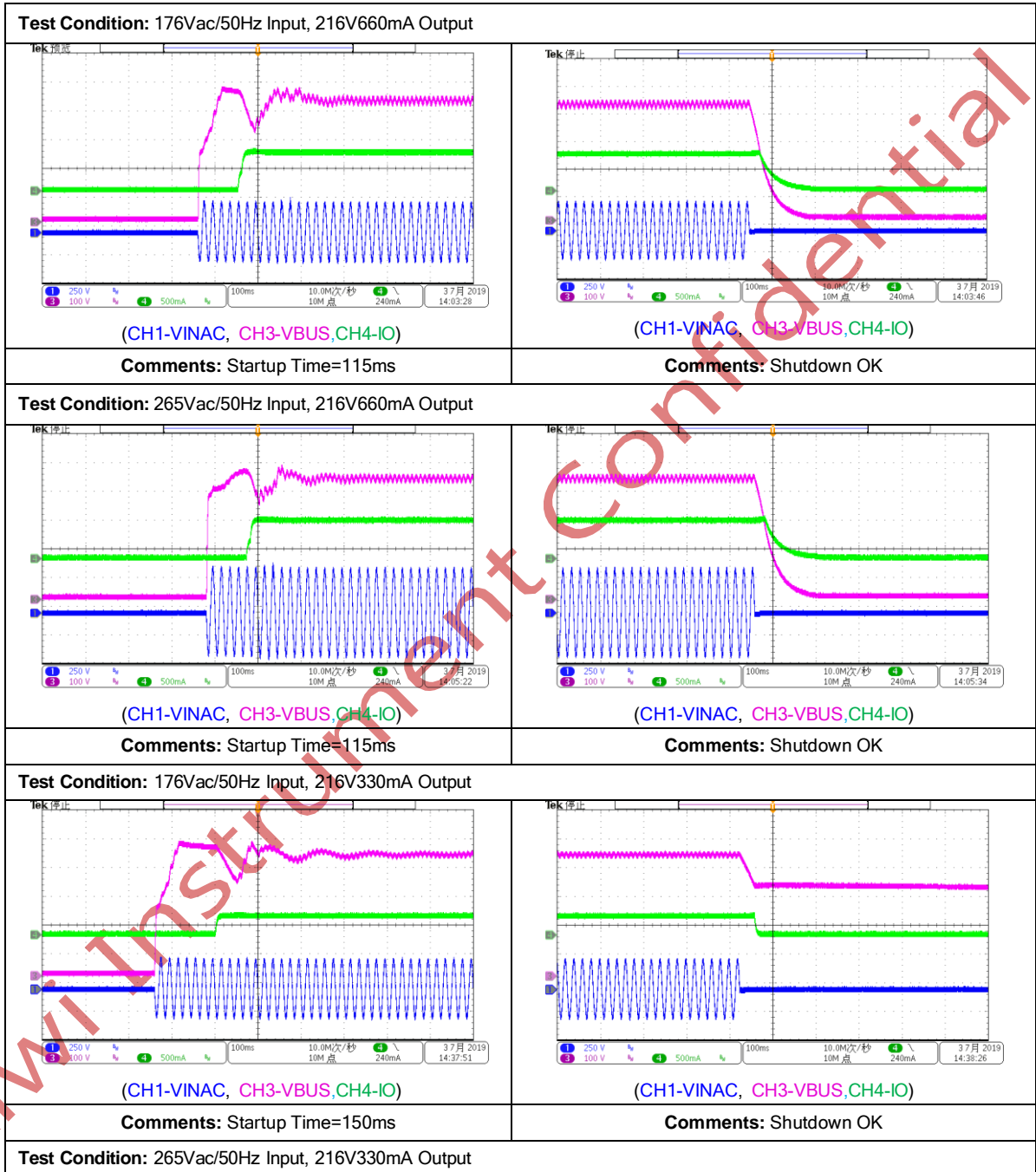





**176-265VAC 150W Two-stage LED Driver with ON/OFF Color Temperature Turning Function Using KP1511SP+KP1073LDP+S4223**

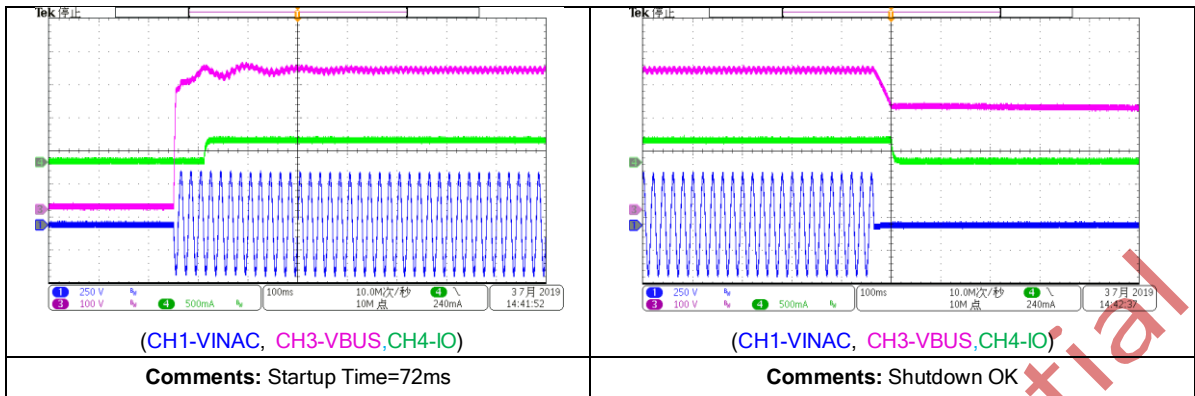

**2) Device Maximum Rating Test**

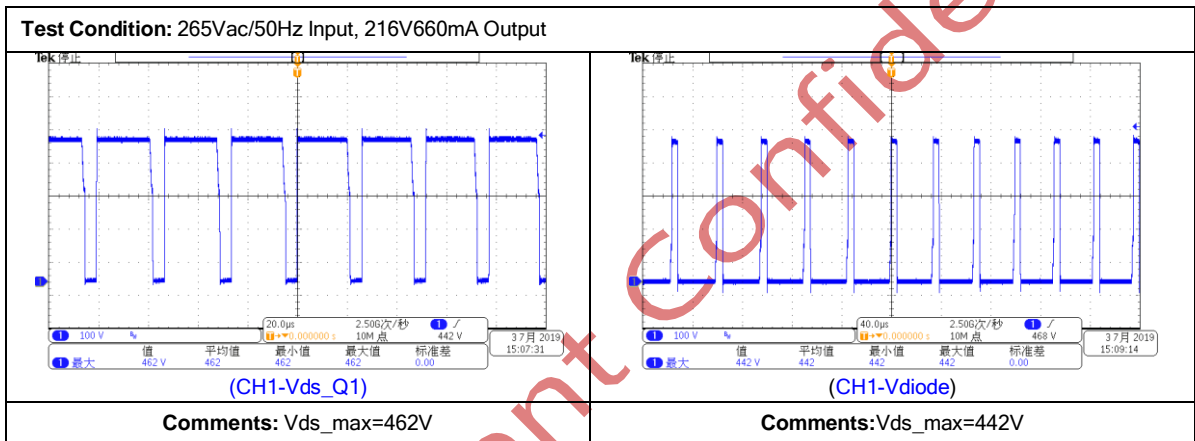

**3) Color Turning Test**

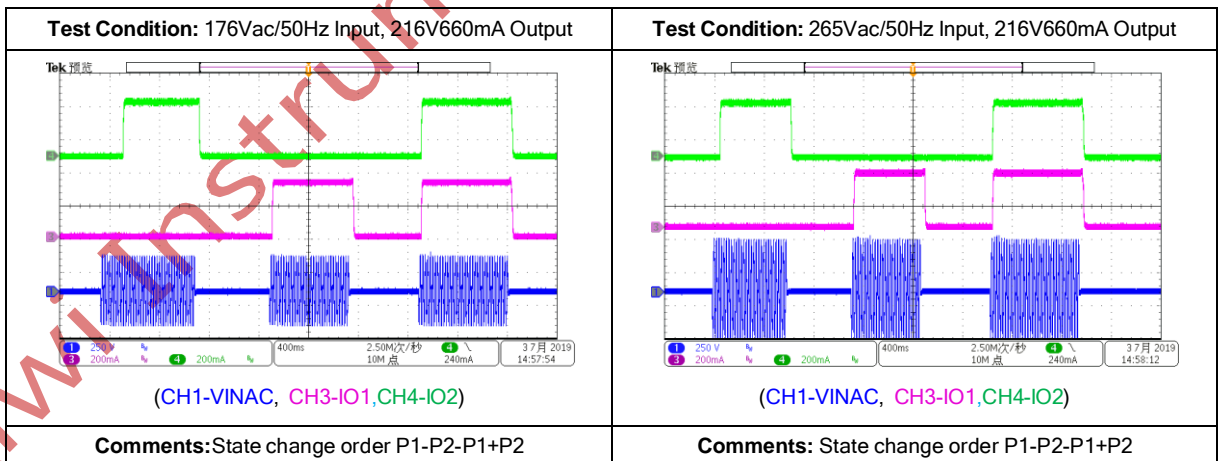

**4) Input Transient Test**

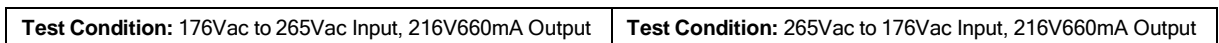

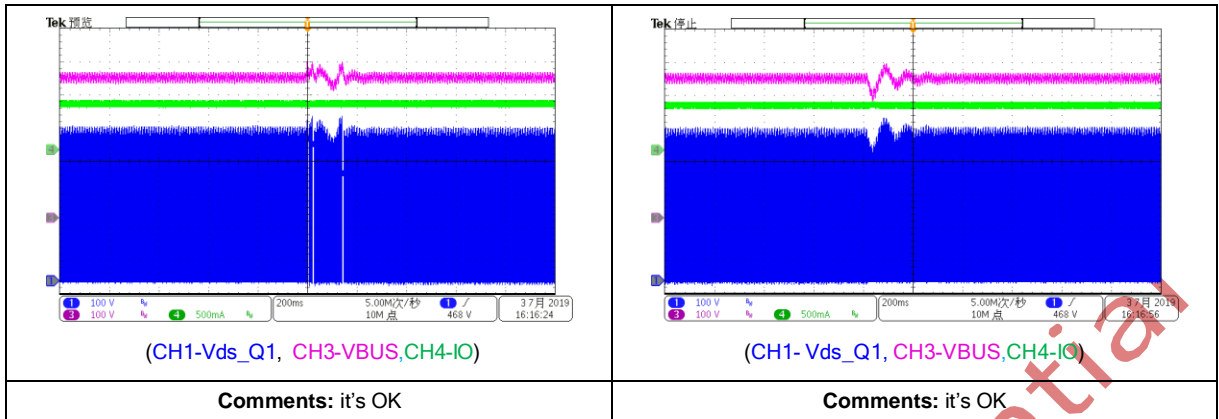

5) The First Stage Output Voltage Ripple Test

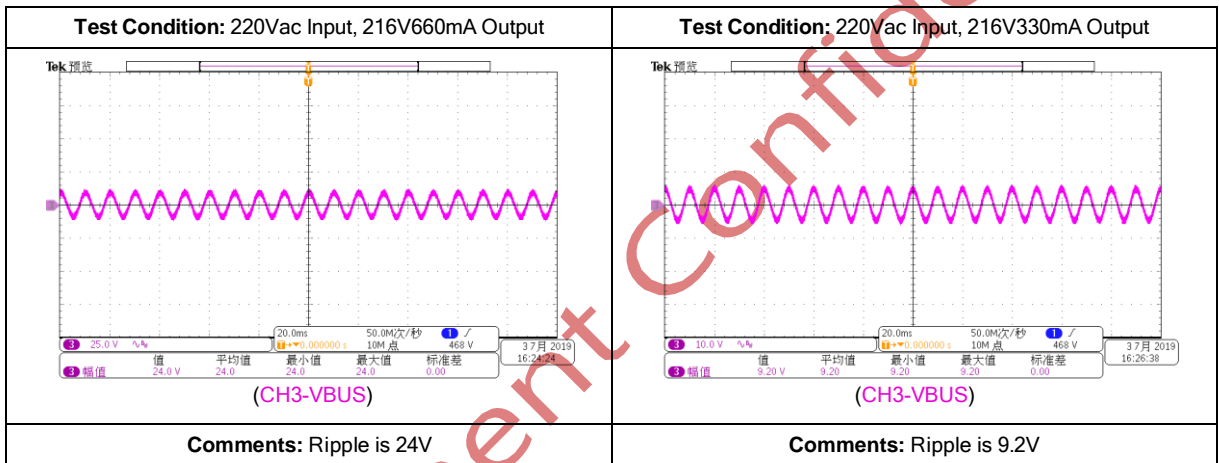

6) Over Voltage Protection Test

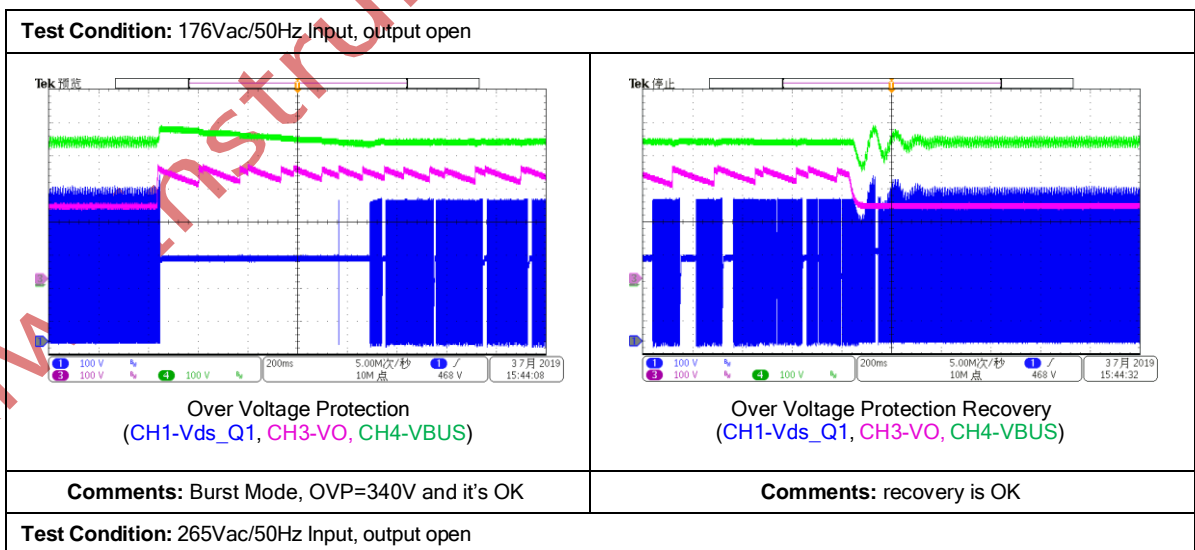

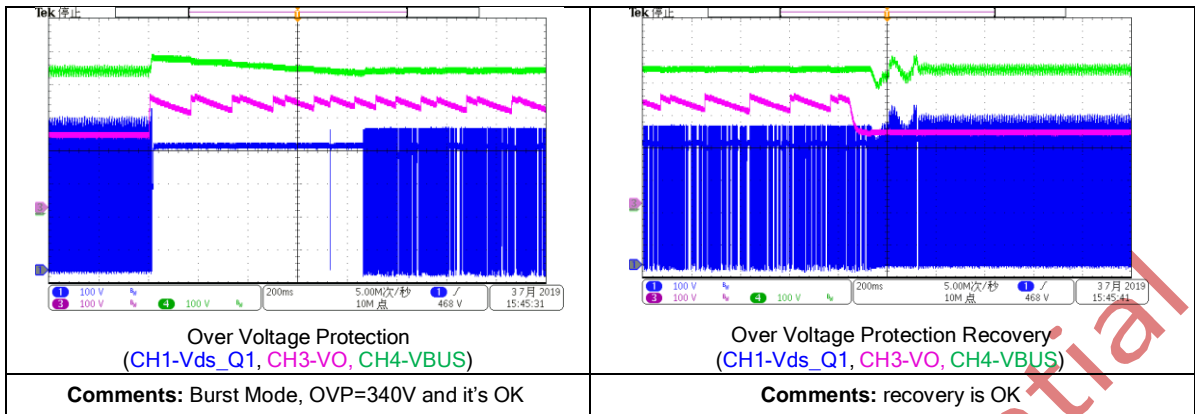

7) Output Short Protection Test

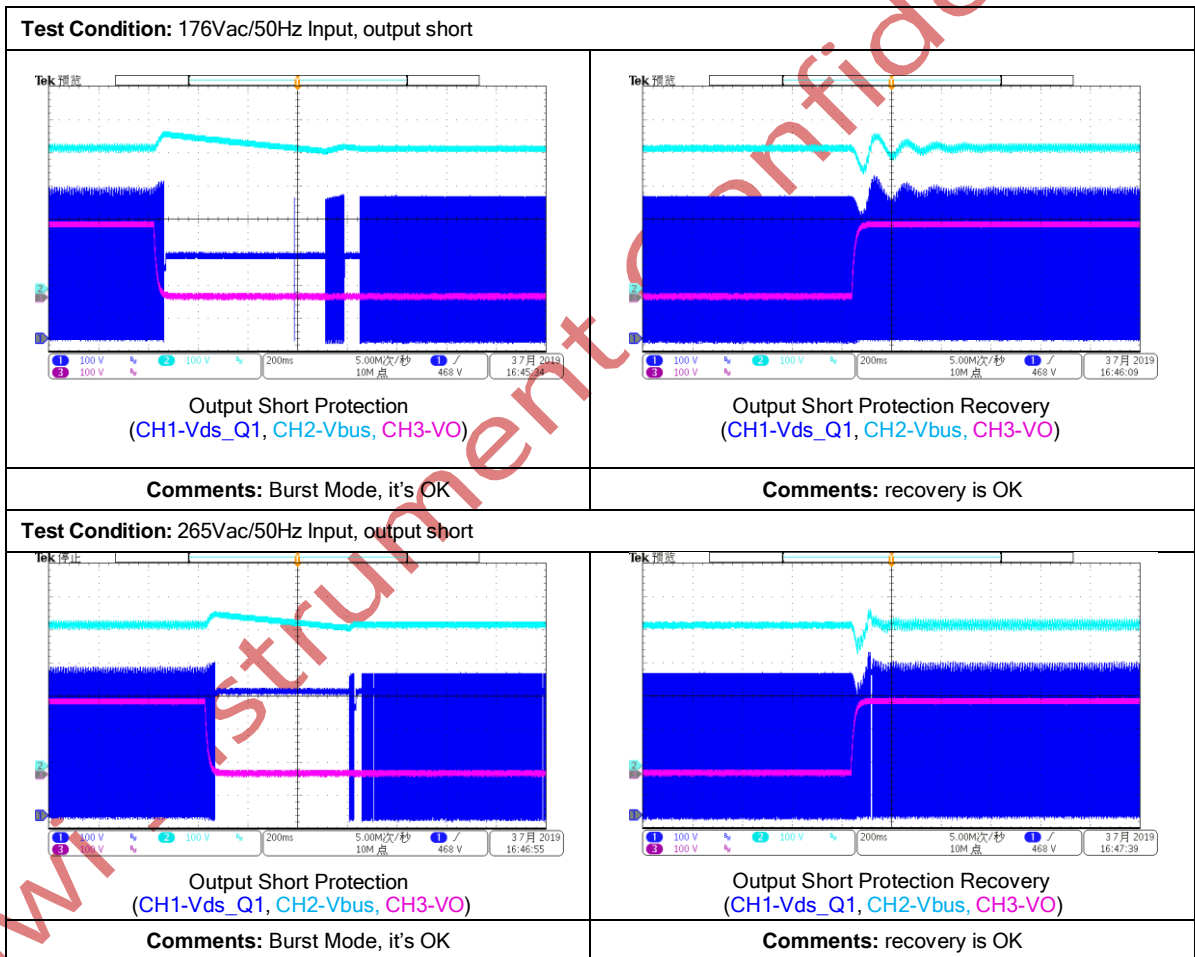



176-265VAC 150W Two-stage LED Driver with ON/OFF Color Temperature Turning Function Using KP1511SP+KP1073LDP+S4223

3. EMC Test Result

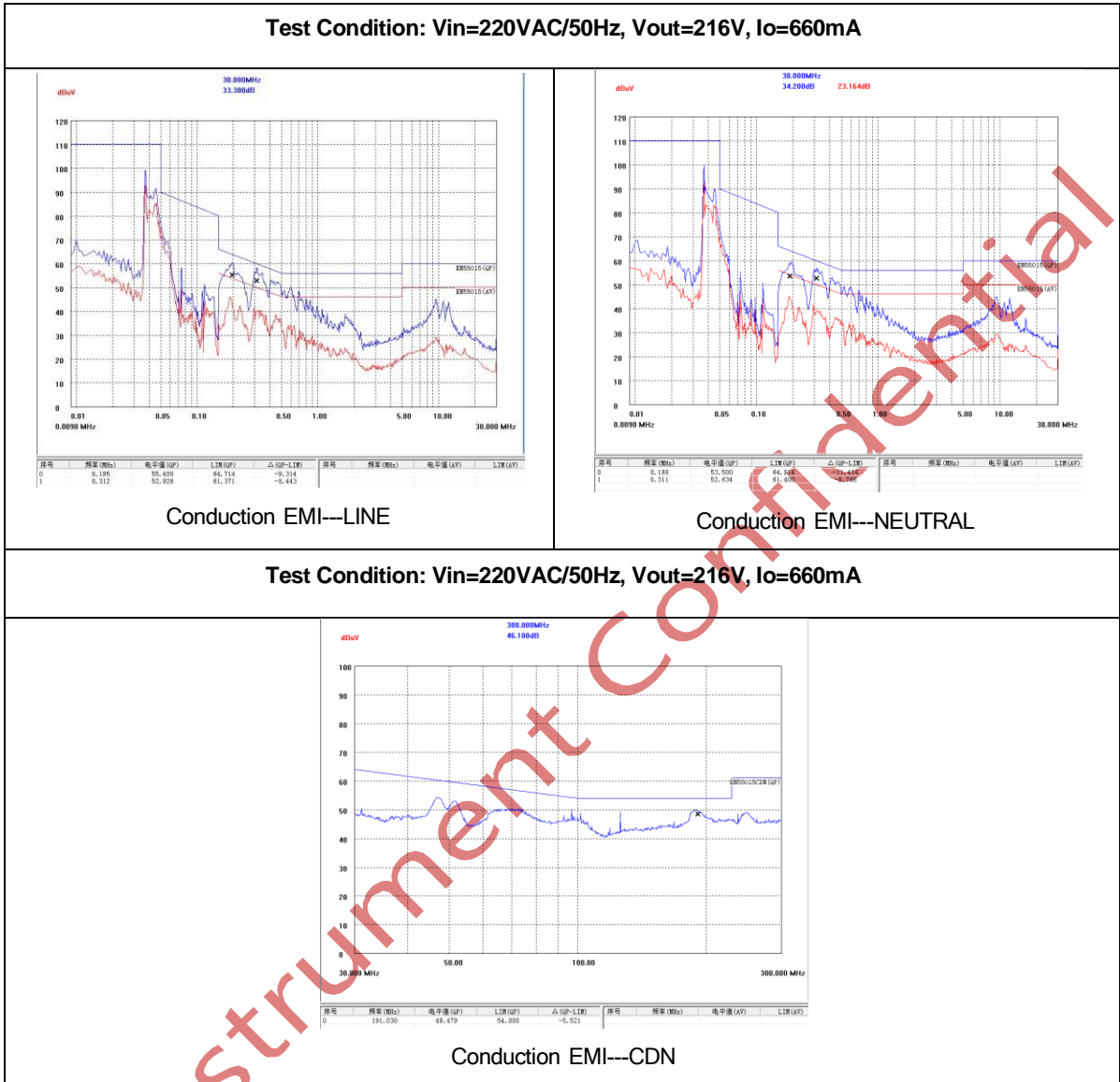

Kiwi Instrument Confidential

#### 4. Thermal Test

**Test Condition:** 176Vac/50Hz, 220Vac/50Hz, 265Vac/50Hz; 216V/660mA output; In the non-convective environment.

	176Vac			220Vac			265Vac		
	Tc(°C)	Ta(°C)	Trise(°C)	Tc(°C)	Ta(°C)	Trise(°C)	Tc(°C)	Ta(°C)	Trise(°C)
IC1	83.1	50.0	33.1	74.6	45.0	29.6	79.6	45.0	34.6
L1(Wire)	68	50.0	18.0	52.3	45.0	7.3	54.5	45.0	9.5
L2(Wire)	87	50.0	37.0	81.7	45.0	36.7	85.1	45.0	40.1
IC2	89.2	50.0	39.2	83.5	45.0	38.5	86.4	45.0	41.4
Q1	98.5	50.0	48.5	69.6	45.0	24.6	64.7	45.0	19.7
D1	78.6	50.0	28.6	69.3	45.0	24.3	70.1	45.0	25.1



Kiwi Inst



### **Test Setup Guide**

1. Connect the “LED+” terminal to the anode of LED string and the “LED-” terminal to the cathode of LED string.
2. Set the AC Power Supply to between 176VAC and 265VAC.
3. Connect the AC Power Source terminal to the “L” and “N” terminals on the Demo Board
4. Turn on the AC Power Source to make system startup; and Turn off the AC Power Source to make system shutdown.

*Kiwi Instrument Confidential*



## Revision History

DATE	REV	DESCRIPTION
2019/07/03	1.0	First Release

## Disclaimer

Information that is provided by Kiwi Instruments Corporation is believed to be accurate and reliable. Kiwi instrument reserves the right to make any change in circuit design, specification or other related things if necessary without notice at any time. No third party intellectual property infringement of the applications should be guaranteed by users when integrating Kiwi instrument products into any application. No legal responsibility for any said applications is assumed by Kiwi Instrument.